

## Work Area Category 6



Modular Jacks.....	6.24
Surface Mount Boxes.....	6.26
Distribution Boxes.....	6.27
Consolidation Boxes .....	6.29
Loaded Faceplates .....	6.31
Patch Cords .....	6.34

# Work Area

## Category 6 – Modular Jacks

### TrueNet® RJ45 UTP and STP Modular KM8® Jacks

The KM8 jack uses the keystone design, the global standard ensuring compatibility with the diverse range of faceplates systems throughout the world. The cable manager holds cable pairs in place up to the termination point. This prevents untwisting and buckling of the conductors thereby guaranteeing performance for every installation.

#### Cable Parameters

Conductor diameter 0.5-0.65mm (AWG 22-24)  
Cable diameter range with insulation 0.7-1.6mm

#### Test Specification

Exceeds specifications according to  
ISO/IEC 11801:2002, EN 50173-1:2002  
and TIA/EIA 568-B

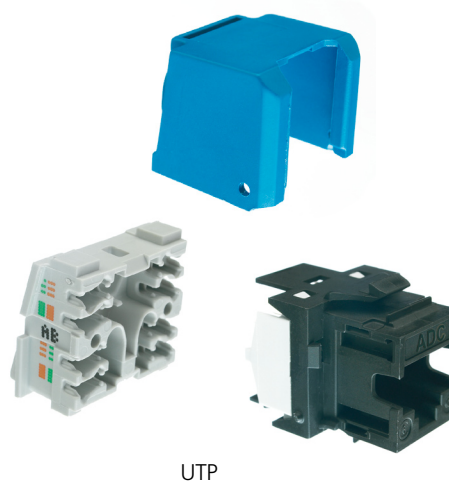

UTP

#### Features

- Performance exceeding Category 6 specifications up to 250MHz
- KM8 cable managed jack in keystone format
- Spring clip on STP version for 360° shield contact ensuring long-term stability
- Fully interoperable and backwards compatible
- Third party certification at a component level
- Maximum throughput, reliability and performance in your IT network
- Third party certification to offer complete peace of mind and guarantee quality
- T-568 A/B wiring
- Covered by the TrueNet® System Warranty

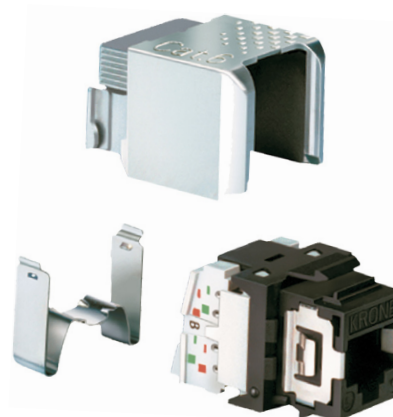

STP

#### Ordering Information

Description	Catalogue Number*
Modular Jack, Category 6 KM8 UTP (Pack of 1)	6830 1 800-0X
Modular Jack, Category 6 KM8 UTP (Bag of 8)	6830 2 710-0X
Modular Jack, Category 6 KM8 STP (Pack of 1)	6830 1 810-0X
Modular Jack, Category 6 KM8 STP (Bag of 8)	6830 2 711-0X

#### \*For X use:

- 1 = White
- 2 = Ivory
- 3 = Grey
- 4 = Black

#### Category 6 Modular KM8 Jack suitable for

Keystone 25x50 Angled Adaptor: 6538 4 111-05 (see page 6.50)  
 U6C Keystone Adaptor: 6830 2 402-00 (see page 6.52)  
 Keystone Faceplates: 6538 3 111-03/04 (see page 6.53)  
 Keystone Faceplate 45x45: 6690 1 825-00 (see page 6.55)  
 European Keystone Faceplate: 6690 2 67X-0X (see page 6.54)  
 Unloaded KM8 Panel: 7022 2 155-16/24/32 (see page 4.58)

# Work Area

## Category 6 – Modular Jacks

### TrueNet® RJ45 UTP and STP Modular CL Jacks

The CL jack is a low profile design which requires less than 35mm of depth (including bend radius of Category 6 cable) making it the perfect solution for shallow trunking, back boxes and floor box applications. In addition, the CL comes complete with an integrated spring dust shutter.

#### Cable Parameters

Conductor diameter 0.5-0.65mm (AWG 22-24)  
Cable diameter range with insulation 0.7-1.6mm

#### Test Specification

Exceeds specifications according to  
ISO/IEC 11801:2002, EN 50173-1:2002  
and TIA/EIA 568-B



UTP

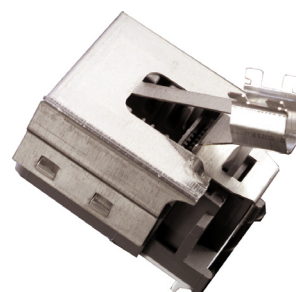

STP

#### Features

- Performance exceeding Category 6 specifications up to 250MHz
- CL low profile design ideally suited to shallow trunking and floor boxes
- Fully interoperable and backwards compatible
- Maximum throughput, reliability and performance in your IT network
- Third party certification to offer complete peace of mind and guarantee quality
- T-568 A/B wiring
- Covered by the TrueNet® System Warranty

#### Ordering Information

Description	Catalogue Number
Modular RJ45 Jack, Category 6 CL UTP, White Shutter (Pack of 1)	6537 1 010-00
Modular RJ45 Jack, Category 6 CL STP In Line, White Shutter (Pack of 1)	6537 1 050-00
Modular RJ45 Jack, Category 6 CL STP Angled, White Shutter (Pack of 1)	6537 1 055-00

#### Category 6 Modular CL Jack suitable for

Standard 25x50 Adaptor: 6540 1 801-00 (see page 6.50)  
Angled 25x50 Adaptor: 6540 1 802-00 (see page 6.50)  
LJ6C Adaptor: 6540 1 810-00 (see page 6.52)  
Angled LJ6C Adaptor: 6540 1 813-00 (see page 6.52)

# Work Area

## Category 6 – Surface Mount Boxes

### TrueNet® RJ45 UTP and STP Surface Mount Boxes

Designed specifically to mount onto surfaces where the wall cavity is not accessible.

#### Dimensions

1 port model: 45 x 26 x 66mm

2 port model: 64 x 26 x 66mm

#### Specification of the Plastic Housing

Security: UL 1863

Flammability class: UL 94 V0

#### Test Specification

Exceeds specifications according to ISO/IEC 11801:2002, EN 50173-1:2002 and TIA/EIA 568-B



#### Features

- Performance exceeding Category 6 specifications up to 250MHz
- Dimensions enable it to be used in restricted spaces
- Utilises the component compliant keystone KM8® jack
- 1 port and 2 port variants
- Available in UTP and STP
- Covered by the TrueNet® System Warranty

#### Ordering Information

Description	Catalogue Number
Surface Mount, Category 6 KM8 UTP, 1 Port	6690 1 600-20
Surface Mount, Category 6 KM8 UTP, 2 Port	6690 1 603-00
Surface Mount, Category 6 KM8 STP, 1 Port	6690 1 600-00
Surface Mount, Category 6 KM8 STP, 2 Port	6690 1 601-00
Surface Mount, Unloaded, 1 Port	7080 2 064-10
Surface Mount, Unloaded, 2 Port	7080 2 065-10

Unloaded Surface Mount Boxes compatible with Category 6 KM8 Jack (see page 6.24)

# Work Area

## Category 6 – Distribution Boxes

### TrueNet® RJ45 UTP Distribution Boxes

Modular high density distribution boxes, enabling multiple connections at the desktop

#### Housing Specification

Casing: Extruded aluminium  
End caps: Moulded plastic

#### Test Specification

ISO/IEC 11801:2002, EN 50173-1:2002  
and TIA/EIA 568-B

#### Dimensions

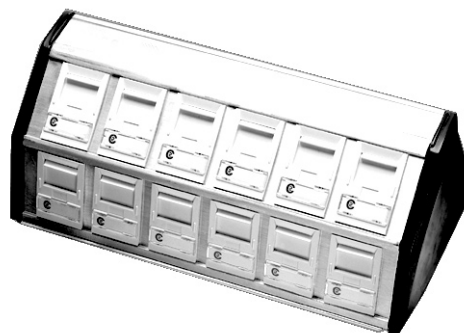
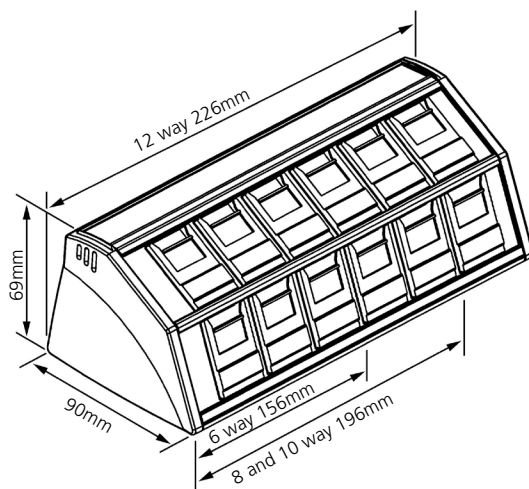

#### Features

- Performance exceeding Category 6 specifications up to 250MHz
- Utilises the component compliant CL jack with integrated dust protection
- Desk and wall mountable for high density applications
- Can be fitted into standard floor boxes
- 6, 8, 10 and 12 way variants available
- Available in UTP only

#### Ordering Information

Description	Catalogue Number
Distribution Box, Category 6 CL UTP, 6 way	6537 1 310-06
Distribution Box, Category 6 CL UTP, 8 way	6537 1 310-08
Distribution Box, Category 6 CL UTP, 10 way	6537 1 310-10
Distribution Box, Category 6 CL UTP, 12 way	6537 1 310-12

# Work Area

## Category 6 – Distribution Boxes

### TrueNet® RJ45 UTP Mini Pod

Designed to help simplify the cabling of raised floor work spaces and is ideal for high density environments, such as desk clusters, call centres, dealer desks and point of sale terminals.

#### Dimensions

85 x 55 x 195mm (excluding gland fittings)

#### Specification of the Plastic Housing

Casing: ABS UL 94 V0

#### Test Specification

Exceeds specifications according to ISO/IEC 11801:2002, EN 50173-1:2002 and TIA/EIA 568-B

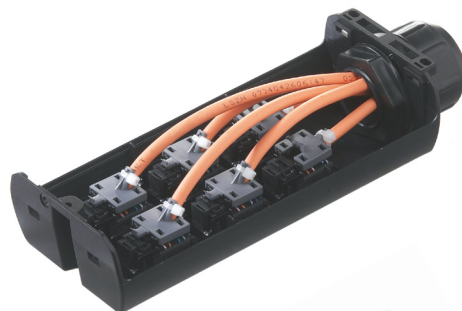

#### Features

- Performance exceeding Category 6 specifications up to 250MHz
- Can be passed through minimum 127mm (5 inch) floor grommets
- Terminations will not be disturbed during repositioning of enclosure, due to external mounting points
- Ideal as a consolidation point with portability without the need to re-enter the enclosure
- 4 port and 6 port variants available
- Sealed unit and shuttered ports provide dust protection
- Provision for a 32mm gland style fixing to be used in conjunction with flexible conduit

#### Ordering Information

Description	Catalogue Number
Mini Pod, Category 6 CL UTP, 4 Port	6540 1 678-04
Mini Pod, Category 6 CL UTP, 6 Port	6540 1 678-06

# Work Area

## Category 6 – Consolidation Boxes

### TrueNet® Consolidation Box (HighBand® Ultim8® Modules)

Connection boxes loaded with HighBand® Ultim8® modules. Used to provide a transition point so that outlet positions can be moved frequently and efficiently without disturbing the horizontal cabling.

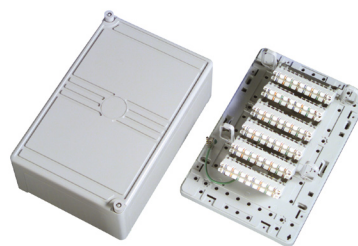

#### Dimensions

250 box: 210 x 160 x 90mm  
300 box: 320 x 210 x 120mm

#### Test Specification

Exceeds specifications according to ISO/IEC 11801:2002, EN 50173-1:2002 and TIA/EIA 568-B

#### Features

- Performance exceeding Category 6 specifications up to 250MHz
- Will accept up to 12 cables, 48 pairs
- Utilises the high performance Ultim8® module
- 3 and 6 module variants available
- Flexible cable entry and dust protection

#### Ordering Information

Description	Catalogue Number
250 Box with 3 x 8 Pair HighBand® Ultim8® Disconnection Modules	6530 1 106-00
300 Box with 6 x 8 Pair HighBand® Ultim8® Disconnection Modules	6530 1 105-00

# Work Area

## Category 6 – Consolidation Boxes

### TrueNet® RJ45 UTP Consolidation Box (CL Jacks)

Connection boxes loaded with RJ-K CL jacks. Used to provide a transition point so that outlet positions can be moved frequently and efficiently without disturbing the horizontal cabling.



#### Dimensions

250 box: 210 x 160 x 90mm

#### Test Specification

Exceeds specifications according to ISO/IEC 11801:2002, EN 50173-1:2002 and TIA/EIA 568-B

#### Features

- Performance exceeding Category 6 specifications up to 250MHz
- Will accept up to 12 cables, 48 pairs
- 12 jack UTP variant only
- Flexible cable entry and dust protection
- CL jacks come complete with shuttered dust protection

#### Ordering Information

Description	Catalogue Number
250 Box with 12 UTP Jacks, CL	6525 1 068-00

# Work Area

## Category 6 – Loaded Faceplates

### TrueNet® RJ45 KM8® UTP and STP Outlets UK Style

UK style faceplates featuring the component compliant modular KM8 jacks for LAN cabling systems satisfying Category 6 requirements.

The Category 6 KM8 jack utilises the innovative 'wire-management' system that ensures zero untwist and buckle to the cable.

#### Dimensions

KM8 double: 86 high x 86 wide x 16mm deep  
 KM8 quad: 86 high x 146 wide x 16mm deep

#### Test Specification

Exceeds specifications according to ISO/IEC 11801:2002, EN 50173-1:2002 and TIA/EIA 568-B



#### Features

- Performance exceeding Category 6 specifications up to 250MHz
- Double and quad variants available in UTP and STP
- Comes complete with jacks, adaptors, faceplate and fixings
- Adaptors come complete with integrated dust protection
- Utilises the UK style deep faceplate with 6mm of added depth ideal for Category 6 installations into shallow back boxes

#### Ordering Information

Description	Catalogue Number
Loaded Faceplate, Category 6 KM8 UTP, Double	6540 1 812-07
Loaded Faceplate, Category 6 KM8 UTP, Quad	6540 1 812-09
Loaded Faceplate, Category 6 KM8 STP, Double	6540 1 812-08
Loaded Faceplate, Category 6 KM8 STP, Quad	6540 1 812-10

# Work Area

## Category 6 – Loaded Faceplates

### TrueNet® RJ45 KM8® UTP and STP Outlets 50x50 European Style

The European style 50x50 faceplates feature the component compliant modular KM8 jack for LAN cabling systems satisfying Category 6 requirements.

The Category 6 KM8 jack utilises the innovative 'wire-management' system that ensures zero untwist and buckle to the cable.

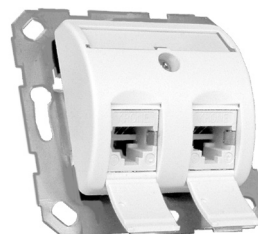

#### Dimensions

86 high x 80 wide x 24mm deep

#### Test Specification

Exceeds specifications according to ISO/IEC 11801:2002, EN 50173-1:2002 and TIA/EIA 568-B

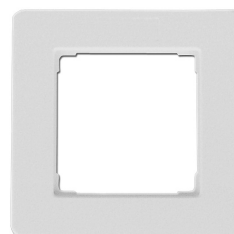

#### Features

- Performance exceeding Category 6 specifications up to 250MHz
- Double variants available in UTP and STP
- Modular construction ensures swift installation
- The 50x50 backplate allows universal installation in trunking systems
- Integrated dust cover
- Covered by the TrueNet® System Warranty

#### Ordering Information

Description	Catalogue Number
Loaded Faceplate, Category 6 KM8 UTP, Double, Pure White	6690 1 581-71
Loaded Faceplate, Category 6 KM8 UTP, Double, Ivory	6690 1 581-22
Loaded Faceplate, Category 6 KM8 STP, Single, Pure White	6690 1 581-61
Loaded Faceplate, Category 6 KM8 STP, Single, Ivory	6690 1 581-12
Loaded Faceplate, Category 6 KM8 STP, Double, Pure White	6690 1 581-51
Loaded Faceplate, Category 6 KM8 STP, Double, Ivory	6690 1 581-02
Cover Frame to adapt outer dimensions of 50x50 outlet to 80x80, Pure White	6690 1 725-01
Cover Frame to adapt outer dimensions of 50x50 outlet to 80x80, Ivory	6690 1 725-00

# Work Area

## Category 6 – Loaded Faceplates

### TrueNet® RJ45 KM8® UTP and STP Outlets 45x45 European Style

The European style 45x45 faceplates feature the component compliant modular KM8 jack for LAN cabling systems satisfying Category 6 requirements. The design of the jack housing allows for additional bend radius space within the trunking.

The Category 6 KM8 jack utilises the innovative 'wire-management' system that ensures zero untwist and buckle to the cable.

#### Dimensions

80 high x 80 wide x 32mm deep

#### Test Specification

Exceeds specifications according to ISO/IEC 11801:2002, EN 50173-1:2002 and TIA/EIA 568-B



#### Features

- Performance exceeding Category 6 specifications up to 250MHz
- Available in UTP and STP, single and double formats
- Integrated dust protection for optimal jack protection
- The 45x45 backplate allows universal installation in trunking systems
- Additional patch cord protection through the arrangement of the jacks

#### Ordering Information

Description	Catalogue Number
Loaded Faceplate, Category 6 KM8 UTP 45x45, 1 Port, Pure White	6690 1 741-11
Loaded Faceplate, Category 6 KM8 UTP 45x45, 2 Port, Pure White	6690 1 741-01
Loaded Faceplate, Category 6 KM8 STP 45x45, 1 Port, Pure White	6690 1 740-11
Loaded Faceplate, Category 6 KM8 STP 45x45, 2 Port, Pure White	6690 1 740-01
Surround Faceplate, 80x80 for 45x45 Outlet, Pure White	6690 3 745-01

